

DVR Menu Settings, Continued

9 Speed

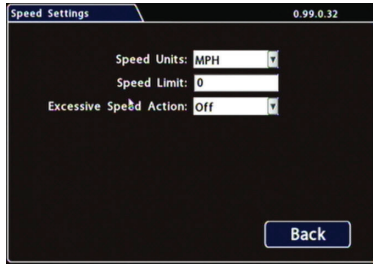

Speed Units: Choose MPH for US or KPH for Canada.
Speed Limit: Set the speed limit to trigger a speed limit action (Signals 1-10 or Alarms 1-4).
Excessive Speed Action: Set the action if requested.
 Click **Back** to save the menu settings. Click **Back** again to return to the Configuration main menu. Click **Network**.

10 Network

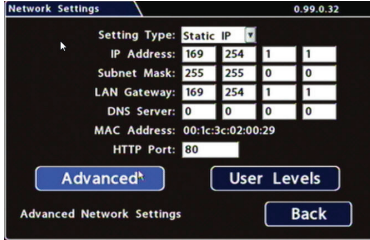

Setting Type: Leave at default Static IP setting.
 Use the IP address shown to communicate with the DVR over the network with vMax Web.
 If the DVR is attached to a Wi-Fi bridge, change these settings to those supplied by the system administrator.
 Typically, leave **HTTP Port** set to 80 unless otherwise instructed by IT personnel.

If the IP information is changed and saved in a configuration file for upload to other DVRs, their settings will have to be updated as well. See DVR Configuration Uploads, in the *TH6 DVR Installation Guide*. Click **User Levels**.

11 Users

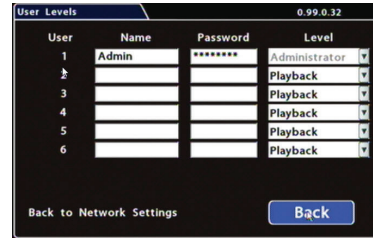

Users logging on to the DVR locally or remotely should have password control to protect the DVR from being accidentally reconfigured. Leave the default Admin user and add other users with access levels as needed. Enter user names, passwords, and assign levels.

- **Admin** user has complete DVR control.
- **Configure** user cannot edit user levels.
- **Playback** user can only view and archive recordings.

Click **Back** to save the menu settings, then click **Back** again to return to the Configuration main menu. Click **System**.

12 System

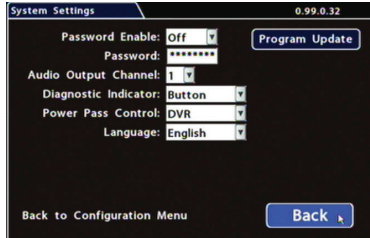

Password Enable: Leave Off unless instructed otherwise.
Password: If enabled, this password is required for non-Admin users to access the local DVR UI.
Audio Output Channel: Select the audio channel that will be available from the audio RCA port on the front of the DVR.
Diagnostic Indicator: If installing a Diagnostic Indicator button or RGY Illuminator, select which one.

Power Pass Control: If required, select Thru or DVR.

Language : Select the language for local DVR UI and vMax Web. Click **Program Update**.

13 Create/Load Configuration File, Format Drive

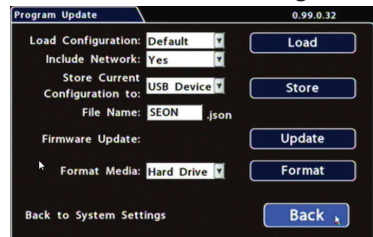

Store Current Configuration: Select USB Device as the file saving destination. Plug a USB memory device into the front of the DVR. Click **Store** to save the file on the USB memory device.
Load: For details on uploading configurations to the DVR, see DVR Configuration Uploads in the *TH6 DVR Installation Guide*.
Update: Firmware updates can also be

delivered by a USB device. The DVR reboots when updates are done.

Format: Format the hard drive when the configuration is complete and tested and before final delivery of the installation to the customer.

Click **Back** to save the menu settings and exit the menus.

inView Guardian TH6 DVR Quick Install Guide

This Quick Install guide is a basic install and setup reference for the TH6 DVR. Review it completely before installing the DVR. For further documentation and training on installing and using this product, visit the Fire Research website:

<https://www.fireresearch.com/product.php?id=snb200>

Installation Diagram

Guardian TH6

Typical System Setup

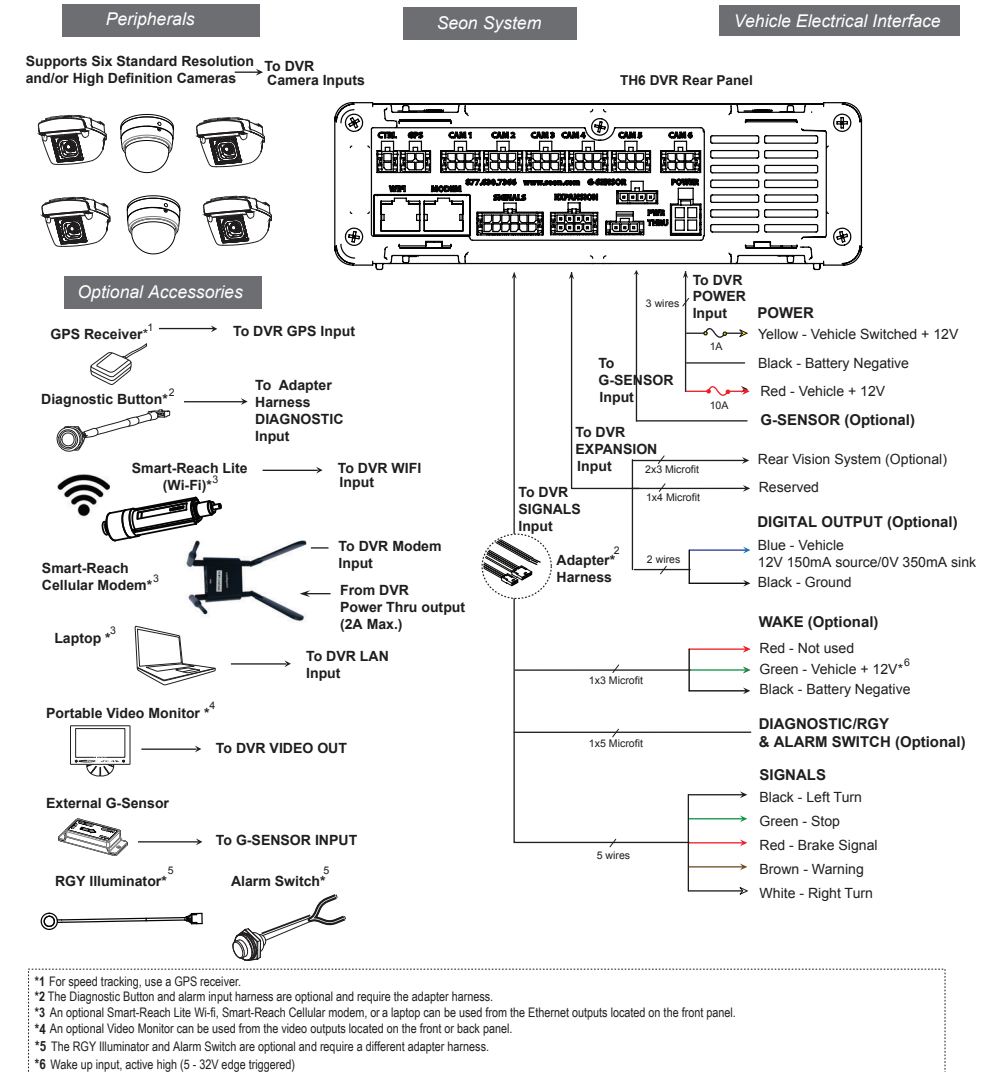

Warranty

For full warranty information, go to <https://www.fireresearch.com/pdf/PricebookWarrantyPage.pdf>.

Customer Service Contact Information

Toll free telephone 1-800-645-0074	Local telephone 631-724-8888	Email: service@fireresearch.com	Web: www.fireresearch.com
------------------------------------	------------------------------	---	---

DVR Installation

The DVR can be installed horizontally or vertically. Do not install the DVR upside down.

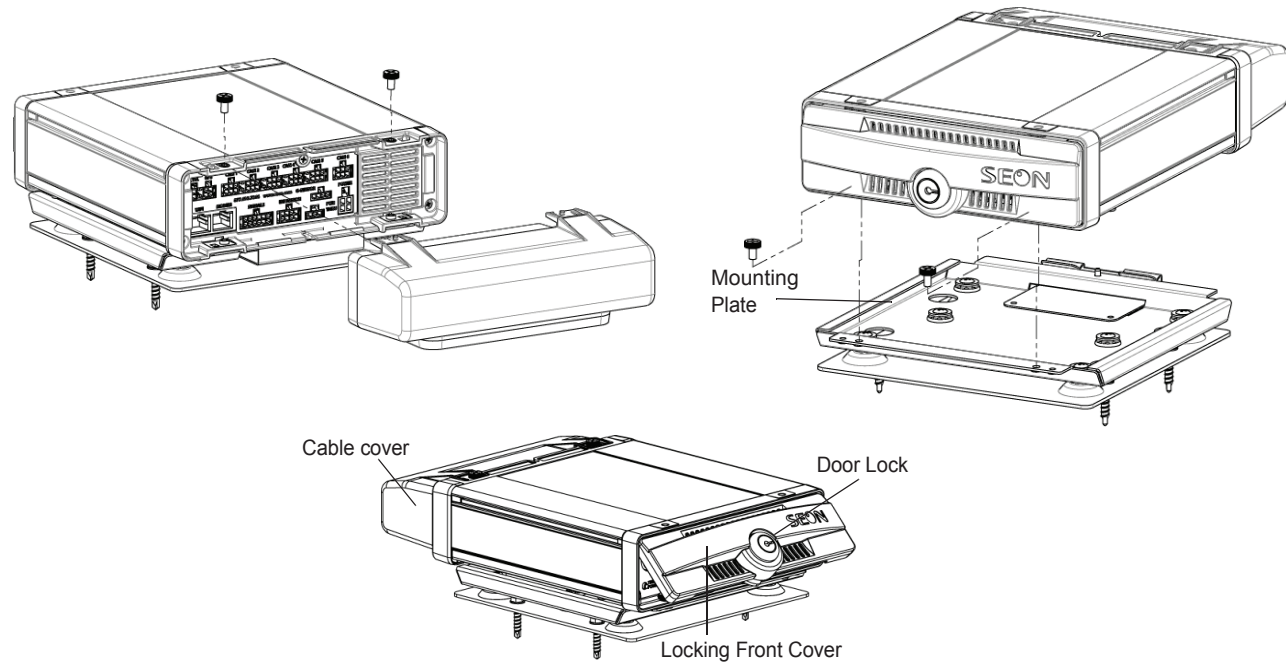

INSTALL TIP: Avoid Locations with Heat or Moisture Exposure When Installing

Do not install the DVR in a location where the unit is exposed to excessive heat or moisture. Installation close to extreme heat or moisture will void the product warranty.

Route the wiring and cables away from sharp edges that might damage the insulation. Avoid sharp bends in the cable. Contact FRC before attaching the DVR to other equipment in the vehicle.

Powering the System On

Turn the vehicle ignition on to power up the DVR. When the PWR LED shows green and the HDD LED flashes green, the DVR is operating normally and recording.

DVR Menu Setup

Depending on any options installed, the DVR needs to have some menu settings updated to operate properly. To access the DVR menu settings, connect a portable video monitor and mouse to the DVR.

Connect a portable video monitor to VIDEO OUT on the TH6 front panel
Connect a USB mouse to the USB mouse port on the TH6 front panel

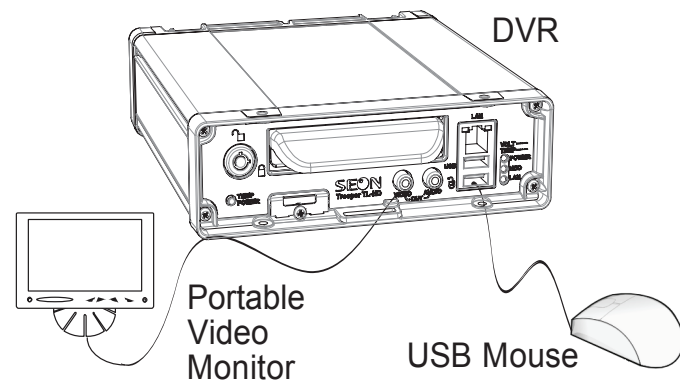

Camera Views

Right-click anywhere in this view to access DVR menus.
Return to this view after updating menus.



DVR Menu Settings

Click Back on menus to save updated settings. See the *TH6 DVR Install and Setup Guide* for full menu details.

1 Main Menu

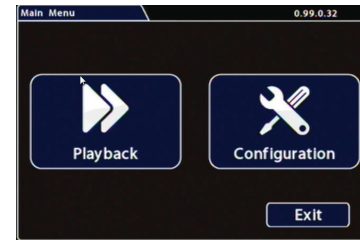

Click **Configuration** to access the Configuration menu.

3 Time/Date

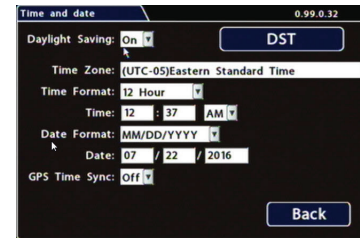

Daylight Saving: Leave this **On** and at default dates unless in an area that does not use daylight savings (ex: Arizona, Saskatchewan).

Time Zone: Select your local time zone.

Time Format: Choose 12 or 24 hour display.

Time: Input the correct time.

Date Format: Select the date format.

Date: Input the date.

GPS Time Sync: If GPS is installed, set this **On** to have system time automatically updated when satellites are detected.

Click **Back** to save the menu settings. In the Configuration menu, click **Title/Display**.

5 Record

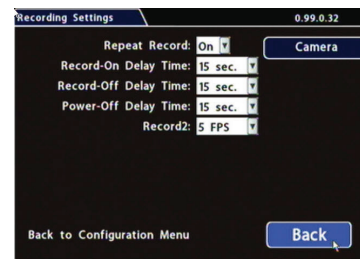

Repeat Record: Leave **On** for the hard drive to record over the first recordings when it is full.

Record-On Delay Time: Leave at default to let the bus voltage settle after the bus starts up, to prevent voltage drops affecting the DVR.

Record-Off Delay Time: If you want to keep the DVR and cameras on after the ignition turns off (e.g. to record the post-trip check), set to 10-20 minutes.

Power-Off Delay Time: This starts up after Record Delay Off time ends. If Wi-Fi is used, set to 2 hours or more. If no Wi-Fi, leave at default.

Leave **Record2** at 5 FPS unless instructed otherwise.

Click **Camera** to access camera settings.

7 Signals

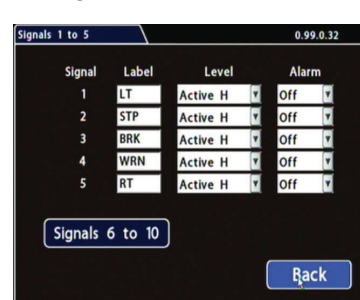

Label: For signals 1-5, select from: LT left turn, STP stop, BRK brake, WRN warning light, and RT right turn. The labels can be edited.

Signals 6-10 are available for advanced signal wiring if equipped. Maximum 3 character.

Level: Set all signal levels as required.

Choose Active High if the circuit you are installing into rests at 0 VDC and goes to 12 VDC when active.

Choose Active Low if the circuit rests at 12 VDC and drops to 0 VDC when active.

Alarm: If a signal is used to trigger an alarm, that alarm's input must also be set up in the Alarms menu.

Click **Back** to save the menu settings. In the Alarms and Signals menu, click **Alarms**.

2 Configuration Menu

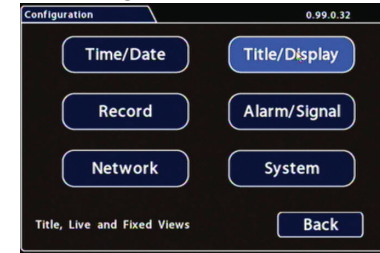

Click **Time/Date** to access the Time and Date menu.

4 Titles/Display

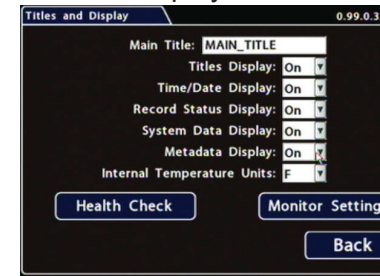

Main Title: Enter the bus number.

Titles Display: Leave **On** to overlay Main Title and Camera Name on video images in live and recorded views (see "Camera Views", below).

If you want to remove a text overlay (**Titles**, **Time/Date**, **Record Status**, **System Data**, or **Metadata**) to reveal more of the video image, set its **Display** value to **Off**.

Click **Back** to save the menu settings. In the Configuration menu, click **Record**.

6 Cameras

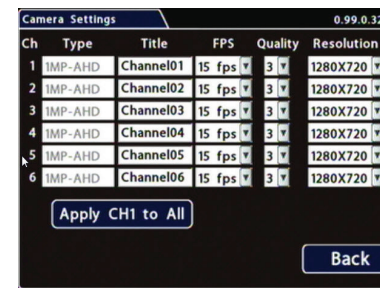

Set unused camera FPS speeds to Off, so the DVR will not generate video loss events.

Title: For each camera, enter a name that describes the view it is recording, such as "front", "step", "mid", or "rear".

FPS: Leave the channel speed at default settings unless you have special requirements.

Quality: Leave the channel quality at default settings unless you have special requirements.

Resolution: Leave the channel resolution at default settings unless you have special requirements. **Audio:** Leave audio settings On unless the camera is mounted on the exterior of the vehicle.

Click **Back** to save the **Camera** menu settings, then click **Back** to return to the Configuration menu. In the Configuration menu, click **Alarm/Signal**. In the Alarms and Signals menu, click **Signals**.

8 Alarms

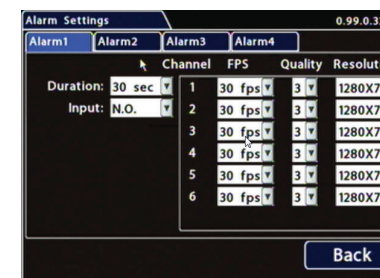

Set unused Channel speeds to Off, so the DVR will not generate video loss events.

Alarm: Alarm 1 comes from the Diagnostic button. Alarms 1-4 can come from signals.

Duration: Set the Duration for how long the DVR will record video flagged as an alarm.

Input: Applies to Alarm 1 only. Choose Normally Open or Normally Closed, depending on the switch type used.

FPS (frames/second), Quality, and Resolution: For each alarm, select higher settings for better video while the alarm is recording.

Click **Back** to save the menu settings. In the Alarms and Signals menu, click **Speed**.